

U.S. Suggested Retail Price List

HCPCS E0638

January 2015

Phone: 1-800-336-7684

Fax: 704-882-0751

www.r82.com

PO Box 1739 Matthews, NC 28106

Account No. _____ Drop Ship: _____
 Date: _____ Name _____
 P.O. Number: _____ Address _____
 Buyer: _____ City _____
 Marked For: _____ State _____ Zip _____
 E Mail: _____ Tel. _____ Fax _____

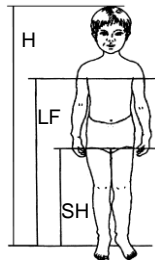

H (Height) _____
 LF (Chest Height) _____
 SH (Groin height) _____
 User weight _____

Features included in standard price:

- Frame
- Locking casters
- Center bar
- Easy crank tilt system

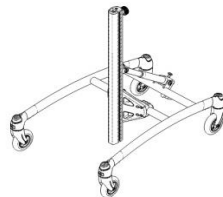

Size 2 grows to size 3
 Size 4 grows to size 5

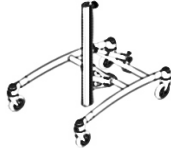
Description	HCPCS	Size	Part No.	Price
	Toucan Standing frame, red	E0638	1	861001 1,275 <input type="checkbox"/>
	Toucan Standing frame, blue	E0638	2	861002 1,275 <input type="checkbox"/>
	Toucan Standing frame, blue	E0638	3	861003 1,275 <input type="checkbox"/>
	Toucan Standing frame, blue	E0638	4	861004 1,420 <input type="checkbox"/>
	Toucan Standing frame, blue	E0638	5	861005 1,420 <input type="checkbox"/>

Accessories











Chest support, size 1 bar, size 2/3 chest pad	1	861704	205 <input type="checkbox"/>
Chest support, Height & Width Adjustable	2+3	861702	205 <input type="checkbox"/>
Chest support, Height & Width Adjustable	4+5	861703	225 <input type="checkbox"/>



Chest support, "Pony style" thick chest pad	1	861801	295 <input type="checkbox"/>
Chest support, "Pony style" thick chest pad	2+3	861802	295 <input type="checkbox"/>
Chest support, "Pony style" thick chest pad	4	861803	295 <input type="checkbox"/>

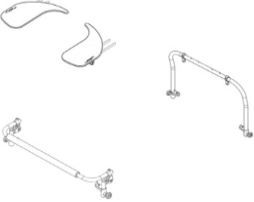
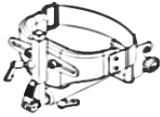
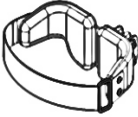
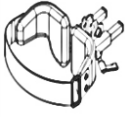
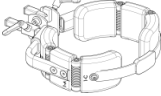

Chest Support, Mustang style	small	861810	490 <input type="checkbox"/>
Chest Support, Mustang style	medium	861820	510 <input type="checkbox"/>
Chest Support, Mustang style	large	861830	540 <input type="checkbox"/>

	Description	Size	Part No.	Price	
	Extra pad for Mustang style chest support	one size	869225	61	<input type="checkbox"/>
	Cover for Mustang style chest support	small	869810-160	115	<input type="checkbox"/>
	Cover for Mustang style chest support	medium	869820-260	140	<input type="checkbox"/>
	Cover for Mustang style chest support	large	869830-360	150	<input type="checkbox"/>
	Filler Pad, small - adds 1" expansion to chest or hip pads		861421	82	<input type="checkbox"/>
	Filler Pad, large - adds 2" expansion to chest or hip pads		861422	82	<input type="checkbox"/>
	Tray with storage box	one size	862501	395	<input type="checkbox"/>
	Tray, plastic, grey	one size	862515	385	<input type="checkbox"/>
	Tray with bowl and top plate	1	861121	505	<input type="checkbox"/>
	Tray with bowl and top plate	2	861122	505	<input type="checkbox"/>
	Tray with bowl and top plate	3	861123	505	<input type="checkbox"/>
	Tray with bowl and top plate	4	861124	505	<input type="checkbox"/>
	Tray with bowl and top plate	5	861125	505	<input type="checkbox"/>
	Armrests - Mount on Tray	all sizes	861131	160	<input type="checkbox"/>
	Toybar	all sizes	861135	240	<input type="checkbox"/>
	Grip Handle	all sizes	8910750	405	<input type="checkbox"/>
<i>All hip supports include a strap</i>					
	Hip support w/pommel, Hgt Adjustable	1	861501	505	<input type="checkbox"/>
	Hip support w/pommel, Hgt & Width Adjus	2+3	861502	505	<input type="checkbox"/>
	Hip support w/pommel, Hgt & Width Adjus	4	861503	560	<input type="checkbox"/>
	Hip support, Front mount, Hgt Adjustable	1	861601	235	<input type="checkbox"/>
	Hip support, Front mount, Hgt & Width Ad	2+3	861602	235	<input type="checkbox"/>
	Hip support, Front mount, Hgt & Width Ad	4	861603	265	<input type="checkbox"/>
	Hip support, rotational, Height Adjustable	1	861611	355	<input type="checkbox"/>
	Hip support, rotational, Hgt & Width Adj	2+3	861612	355	<input type="checkbox"/>
	Hip support, rotational, Hgt & Width Adj	4	861613	385	<input type="checkbox"/>
	Hip support, surrounding	2	861610	555	<input type="checkbox"/>
	Hip support, surrounding	2+3	861620	555	<input type="checkbox"/>
	Hip support, surrounding	4	861630	565	<input type="checkbox"/>
	Hip support on curved bar	sizes 1 + 2	869222	385	<input type="checkbox"/>
	Hip support on curved bar	sizes 3 + 4	869232	385	<input type="checkbox"/>

U.S. Suggested Retail Price List

HCPCS E0638





January 2015

Phone: 1-800-336-7684



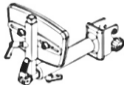
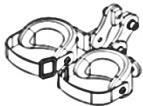

Fax: 704-882-0751

www.r82.com

PO Box 1739 Matthews, NC 28106

	Description	Size	Part No.	Price
	Extension for center profile, 3"	all sizes	861480	82 <input type="checkbox"/>
	Abdominal support	one size	861411	160 <input type="checkbox"/>
	Pommel and sacral support	one size	861401	435 <input type="checkbox"/>
	Knee supports, including straps, set	1	861301	280 <input type="checkbox"/>
	Knee supports, including straps, set	2+3	861302	355 <input type="checkbox"/>
	Knee supports, including straps, set	4+5	861303	355 <input type="checkbox"/>
	Hinged knee supports, including straps, set	1	861311	435 <input type="checkbox"/>
	Hinged knee supports, including straps, set	2+3	861312	435 <input type="checkbox"/>
	Hinged knee supports, including straps, set	4+5	861313	435 <input type="checkbox"/>
	Flip up footplate	1	861211	220 <input type="checkbox"/>
	Flip up footplate	1 - 5	861212	220 <input type="checkbox"/>

FOOTPLATE ACCESSORIES - Require Flip up foot plate

	Shoe holders for flip up footplate	8¼" x 3¾"	86147	165 <input type="checkbox"/>
	Shoe holders for flip up footplate	9¼" x 4½"	86148	165 <input type="checkbox"/>
	Footstraps, plastic lock	one size	36-8596	36 <input type="checkbox"/>
	Hinged sandals (flip up footplate), w/ straps	1	861221	135 <input type="checkbox"/>
	Hinged sandals (flip up footplate), w/ straps	2+3	861222	135 <input type="checkbox"/>
	Hinged sandals (flip up footplate), w/ straps	4+5	861223	135 <input type="checkbox"/>
	Individual footrests with hinged sandal	1	861201	395 <input type="checkbox"/>
	Individual footrests with hinged sandal	2+3	861202	395 <input type="checkbox"/>
	<i>Includes straps</i>			
	Heel stop	small	861251	56 <input type="checkbox"/>
	Heel stop	large	861252	56 <input type="checkbox"/>

U.S. Suggested Retail Price List

HCPCS E0638

January 2015

Phone: 1-800-336-7684

Fax: 704-882-0751

www.r82.com

PO Box 1739 Matthews, NC 28106

Description	Size	Part No.	Price
-------------	------	----------	-------

You must select a Swing-away Mounting Bracket and Headrest Style



HCPCS - E1028

Swing-away Bracket - Height, Depth, Angle & Lateral Adjustable

Mounting for Head support	1 & 2	861424-3	370	<input type="checkbox"/>
Mounting for Head support	3, 4, & 5	861424-4	370	<input type="checkbox"/>



PAD STYLE - Requires mounting bracket

HCPCS - E0955

Head support no. 1, Black Polyurethane (cover optional)	6171550	205	<input type="checkbox"/>
Head support no. 2, Black Polyurethane (cover optional)	6172550	205	<input type="checkbox"/>
Head support no. 3, Black Polyurethane (cover optional)	6173550	205	<input type="checkbox"/>
Head support no. 4, Black Polyurethane (cover optional)	6174550	205	<input type="checkbox"/>
Head support no. 8, (cover required)	5031975	205	<input type="checkbox"/>
Blue Comfort Cover	15	65	<input type="checkbox"/>
Black Decutex Cover	83	65	<input type="checkbox"/>



Anatomic head support, Small, with Black Decutex cover	5099001	255	<input type="checkbox"/>
Anatomic head support, Med., with Black Decutex cover	5099002	255	<input type="checkbox"/>
Anatomic head support, Large, with Black Decutex cover	5099003	255	<input type="checkbox"/>
Headband System (For Anatomic Head Supports Only)	99500	230	<input type="checkbox"/>
Extra headband strap	99400-5	56	<input type="checkbox"/>

Adjustable Headrests - Requires mounting bracket



Adjustable Width Headrest, large laterals, w/o speakers**	99737XX-85	305	<input type="checkbox"/>
Speakers for Adjustable Width Headrest, large laterals**	X99717XX-85	95	<input type="checkbox"/>
Adjustable Width Headrest, Four laterals**	99757XX-85	305	<input type="checkbox"/>
Adjustable Width Headrest, Two laterals**	99777XX-85	305	<input type="checkbox"/>

Adjustable Headrests with Dynamic Feature - Requires mounting bracket

Adjustable Width Headrest, large laterals, w/o speakers**	99736XX-85	385	<input type="checkbox"/>
Speakers for Adjustable Width Headrest, large laterals**	X99716XX-85	95	<input type="checkbox"/>
Adjustable Width Headrest, Four laterals**	99756XX-85	385	<input type="checkbox"/>
Adjustable Width Headrest, Two laterals**	99776XX-85	385	<input type="checkbox"/>

**Includes black Mesh cover



Mounting Bracket Style

HCPCS - E1028

Swing-away Mounting Brackets - Height, Depth, Angle & Lateral Adjustable

Turtle bar system, short	98619-25	230	<input type="checkbox"/>
Turtle bar system, long	98619-26	230	<input type="checkbox"/>

U.S. Suggested Retail Price List

HCPCS E0638

January 2015

Phone: 1-800-336-7684

Fax: 704-882-0751

www.r82.com

PO Box 1739 Matthews, NC 28106

Spare Parts

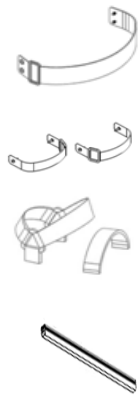

Strap for hip support	1	861621	61	<input type="checkbox"/>
Strap for hip support	2+3	861622	61	<input type="checkbox"/>
Strap for hip support	4+5	861623	61	<input type="checkbox"/>
Straps for knee support, set	1	861341	56	<input type="checkbox"/>
Straps for knee support, set	2+3	861342	56	<input type="checkbox"/>
Straps for Flip up foot plate sandals, set	1	861241	87	<input type="checkbox"/>
Straps for Flip up foot plate sandals, set	2+3	861242	87	<input type="checkbox"/>
Straps for Flip up foot plate sandals, set	4+5	861243	87	<input type="checkbox"/>
Center Profile (Grows size 2 to size 3)		861903	175	<input type="checkbox"/>
Center Profile (Grows size 4 to size 5)		861905	225	<input type="checkbox"/>

Measurements

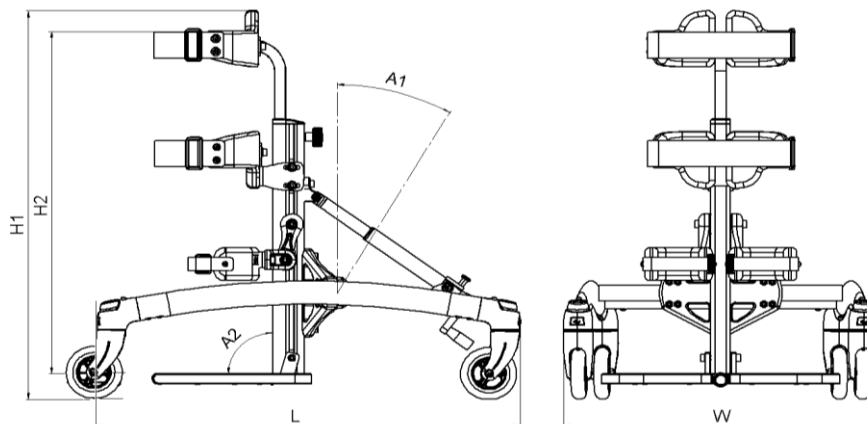

	Size 1	Size 2	Size 3	Size 4	Size 5
Length (L)	29¼"	34¼"	34¼"	43¼"	43¼"
Width (W)	21¾"	24½"	24½"	27¼"	27¼"
Total height (H1)	26¼-34"	28-39½"	37¾-48"	40½-52¼"	48¼-60"
Hgt from foot/chest (H2)	13¼-27¼"	21-35"	29-43"	35½-47¼"	43¼-55"
(H2) hgt w/ extension	16¼-30¼"	24-38"	32-46"	38½-50¼"	46¼-58"
Floor to foot plate min.	2¼"	2¼"	2¼"	2½"	2½"
Angle of center bar (A1)	0° to +30°	0° to +30°	0° to +30°	0° to +20°	0° to +20°
Angle of footplate (A2)	+15° to -10°	+15° to -10°	+15° to -10°	+15° to -10°	+15° to -10°
Max. user weight	67 lb	89 lb	111 lb	132 lb	154 lb
Product weight	16,5 lb	19 lb	20 lb	23 lb	24 lb

NOTES