

R82 Orca/Penguin

USD Retail Price List/ Order Form

Account #: _____ Purchase Order No.: _____ Date: _____
 Contact: _____ Mark For: _____

Bill To:	Ship To:
Address:	Address:
City/State/Zip:	City/State/Zip:
Phone:	Phone:
Email:	

US Configuration

Effective: 01.01.22 Rev 2

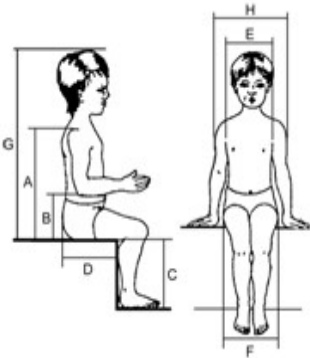

A (Back Height) _____
 B (Arm Height) _____
 C (Lower Leg Length) _____
 D (Seat Depth) _____
 E (Chest Width) _____
 F (Seat Width) _____
 G (Height: Seat to Top of Head) _____
 H (Shoulder Width) _____
 Age _____
 Weight _____

Measurements

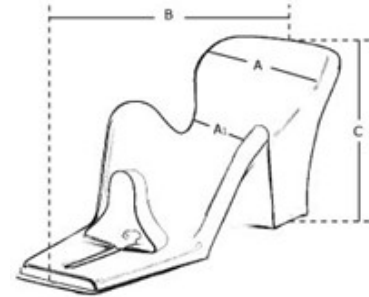
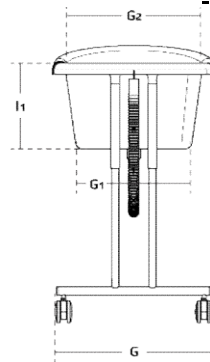
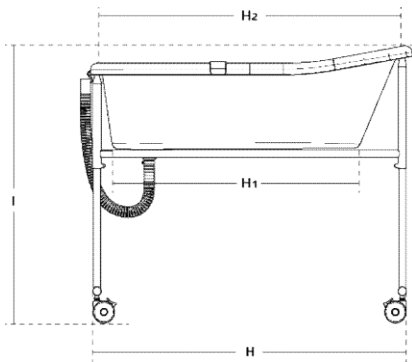









<u>Orca</u>	<u>Inches</u>	<u>Penguin</u>	<u>Inches</u>
Frame height (I)	36¾ - 44¾"	Width (A)	13"
Frame width (G)	21½"	Inside width, tightest place (A1)	6½"
Frame length (H)	43¾"	Length (B)	31"
Bath tub height, inside (I1)	11¼"	Height (C)	10"
Bath tub width, inside, bottom (G1)	15½"	Length, abduction block to top	22 - 28"
Bath tub width, inside, top (G2)	18¼"	Max. load	44 lbs.
Bath tub length, inside, bottom (H1)	33½"		
Bath tub length, inside, top (H2)	40¼"		
Weight	35.5 lbs.		
Max. Load	110 lbs.		

Orca Standard Features



- Orca Bath Tub
- Height Adjustable Frame
- Plug & Drain Pipe
- Soap Tray

Frame	Description	Size	Part No.	USD Price
	<input type="checkbox"/> Orca bath tub on height adjustable frame	One Size	87550	\$2,316
	<input type="checkbox"/> Penguin lying support* <i>*Fits in the Orca Bathtub</i>	One Size	87702	\$667
	<input type="checkbox"/> Flamingo seat and back*	Size 1	880101-61	\$574
	<input type="checkbox"/> Flamingo seat and back*	Size 2	880102-61	\$574
	<input type="checkbox"/> Suction cups for seat	One Size	880150	\$140

Spare Parts	Description	Measurements	Size	Part No.	USD Price
	<input type="checkbox"/> Extension hose		One Size	111555	\$53
	<input type="checkbox"/> Plug and drain pipe for Orca		One Size	87551-1	\$59
	<input type="checkbox"/> Plug for bath tub		One Size	107796	\$12
	<input type="checkbox"/> Soap tray		One Size	107806	\$19

IMPORTANT: No returns or exchanges accepted for this product

**Prices in USD & is subject to change without notice
For Quotes and Orders please send completed Order Form to: sales.us@etac.com or Fax: 1-800-760-0537**

Etac
13137 Bleinheim Lane
Matthews, North Carolina 28105
+1 844-US-MOBILITY (844-876-6245)
www.etac.us.com

OF7400-ENG-REV.02

etac[®]
Creating Possibilities